

PRK LED Specifications



Project Name:

Catalog Number:

Type:

The PRK LED Series offers clean, functional styling that is defined by its sleek low profile design and rugged construction. It combines the latest LED edge-lit Array technology, advanced LED thermal management and provides canopy lighting that is both energy efficient and aesthetically pleasing.

The PRK housing is die-cast aluminum with internal heat sinks for maximum heat dissipation.

The PRK LED fixture offered with lumen packages between 3,000 - 15,000. Four different optical distribution patterns are available. Choose between 3K, 4K, or 5K Kelvin temperature of the LEDs.

A durable polyester powder coat finish is guaranteed for five years; and is available in standard or custom colors.

The PRK series is an exceptional choice for parking garage lighting and other ceiling mount application.

Ordering Information

MODEL	OPTICS	WATTAGE	KELVIN	VOLTAGE	MOUNTING	FINISH	OPTIONS	OPTIONS				
PRK	T1 Type 1 Symmetrical Drive Lane 25W - 95W	25W	3K 3000K	UNV 120-277V	LPM Low Profile Mount Ceiling Mount No conduit feed.	BZ Bronze	UPL Up-light 800 lumens	DIM 0-10v Dimming Driver				
		35W	4K 4000K						8 347V	BK Black	WG Wire Guard	EBPL 20W Emergency Battery Pack
		45W	5K 5000K						5 480V	SBK Smooth Black	WLG Wild Life Guard *Pendant Mount Only	CLD-EBPL 20W Cold Weather Emergency Battery Pack Rated for -20°C
	T3L Type 3 Asymmetrical Perimeter 25W - 85W	55W	CM Ceiling Mount 1/2" & 3/4" Knockouts	TM Trunion Mount	SWH Smooth White	WH White	WSC-8 Dimmable Motion Sensor 8' Mounting Height	UL924 UL 942 Relay for Emergency Circuit				
		65W							PM12 Pendant Mount 12" *30" Leads	GP Graphite	WSC-20 Dimmable Motion Sensor 9-20' Mounting Height	10kV 10kV Surge Protector
		75W										
	T5LR Type 5 Symmetrical Concentrate 25W - 115W	85W	PM36 Pendant Mount 36" *54" Leads	CC Custom Color	VWC Visionaire Wireless Controls *Consult Factory							
		95W				TPH Tamper Proof Hardware						
		105W					HS House Side Shield					
	T5LS Type 5 Symmetrical Wide 25W - 65W	115W										

Features & Specifications

PRK

Housing

Die-Cast aluminum LED housing with integral cooling fins for thermal management. Silicone gasket is used for weather tight operation.

Mounting

A Low Profile, hinged, ceiling mount bracket, can be secured directly to a 4" or 5" recessed junction box, or to the ceiling.

A Ceiling Mount bracket with 1/2" and 3/4" knockouts is also available for surface conduit mounting.

The ceiling hangar bracket on both versions allows the fixture to be suspended while making the wiring connections. The housing bracket then attaches to the ceiling bracket via a tamper-proof screw.

3/8" NPT stem and canopy supplied for pendant mount applications.

Thermal Management

The PRK series provides excellent thermal management by mounting the LEDs to the substantial heat sink within the housing. This enables the Luminaire to withstand higher ambient temperatures and driver currents without degrading LED life.

Optical System

The highest lumen output LED are utilized. High-performance acrylic optics feature industry leading Type I, III, and V optical distributions. Light Guide Panel is impact-resistant and rated to 94 percent translucence.

L70 life of our LEDs is rated over 100,000 hours, The optical system qualifies as IES full cutoff to restrict light trespass, glare and light pollution for neighborhood-friendly lighting.

CRI values are 70.

Quali-Guard® Finish

The finish is a Quali-Guard® textured, chemically pretreated through a multiple-stage washer, electrostatically applied, thermoset polyester powder coat finish, with a minimum of 3-5 millimeter thickness. Finish is oven-baked at 400° F to promote maximum adherence and finish hardness. All finishes are available in standard and custom colors.

Finish is guaranteed for five (5) years.

Electrical Assembly

The PRK LED series accepts 120v -480v, 50 Hz to 60 Hz, input. Power factor of 90%. Rated for -40°C operations.

6 kV surge protector supplied as standard.

Warranty

• Five (5) year Limited Warranty on electrical components, Five (5) year on finish. For full warranty information, please visit visionairelighting.com.

Options

- Watt Stopper FSP-211 Motion Sensor (Title 24 Compliant)
- Dimming Driver
- 20W Emergency Battery Pack
- 20W Cold Weather Emergency Battery Pack (Rated for -20°C)
- UL 924 Relay
- 10kV Surge Protector
- 20kV Surge Protector
- House Side Shield
- Visionaire Wireless Controls
 - Enables high end trim
 - Based on Zigbee wireless communication protocol

Listings

- PRK is UL Listed
- IP66 Rated
- Powder Coated Tough



3000K must be selected for IDA certification.

Motion Sensor Default Setting									
FSP - 211	High Mode	Low Mode	Time Delay	Cut Off Delay	Sensitivity	Hold Off Setpoint	Photocell On/Off	Ramp Up Time	Fade Down Time
WSC - Default	10V	1V	5 Minutes	1 Hour	Max	Disabled	Disabled	Disabled	Disabled
WSC Range	0-10V	0-9.8V	5-30 Minutes	1-5 Hours	Low, Med, Max	1-250FC	1-250FC	1-60 Dec	1-60 Dec

*Settings can be field modified with the FSIR-100 Programming remote

PRK LED Specifications

Photometric Optical Summary

T1 - Type 1
Symmetrical Drive Lane

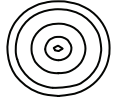

T3L - Type 3
Asymmetrical Perimeter



T5LR - Type 5
Symmetrical Concentrate

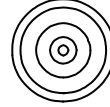

T5LS - Type 5
Symmetrical Wide

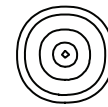

Dimensions

Width: PRK-1 20.5"

Height: PRK-1 3.7"

Weight: 20 LBS

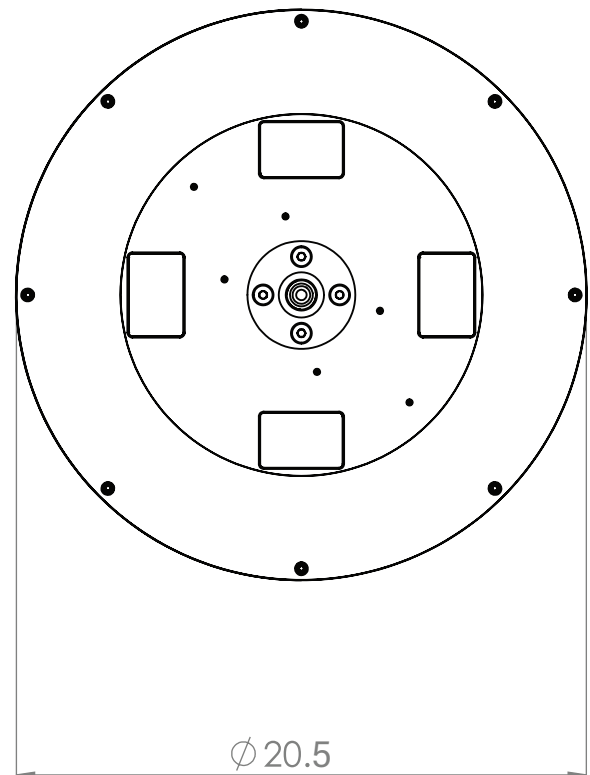
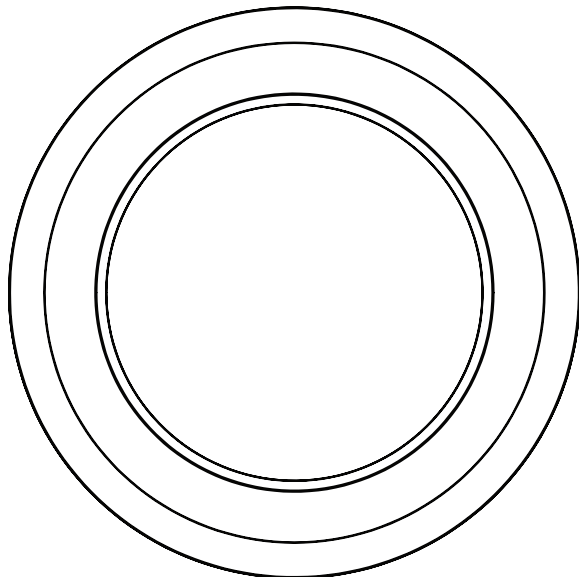
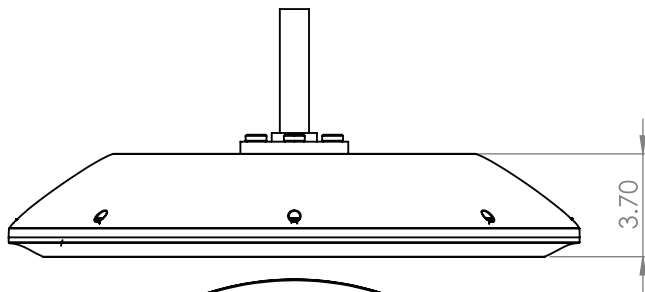

PRK 3K LUMENS								
Wattage	T1	LPW	T3L	LPW	T5LS	LPW	T5LR	LPW
25	3148	126	3135	125	3162	126	3129	125
35	4408	126	4390	125	4427	126	4437	127
45	5592	124	5570	124	5617	125	5712	127
55	6688	122	6662	121	6718	122	6925	126
65	7445	115	7341	113	7478	115	8173	126
75	9341	125	9140	122			9293	124
85	10359	122	9600	113			10375	122
95	10905	115					11379	120
105							12565	120
115							13549	118
PRK 4K LUMENS								
Wattage	T1	LPW	T3L	LPW	T5LS	LPW	T5LR	LPW
25	3232	129	3219	129	3246	130	3213	129
35	4525	129	4507	129	4546	130	4555	130
45	5741	128	5719	127	5767	128	5864	130
55	6867	125	6840	124	6897	125	7109	129
65	7644	118	7537	116	7677	118	8391	129
75	9590	128	9384	125			9542	127
85	10636	125	9856	116			10652	125
95	11196	118					11682	123
105							12901	123
115							13911	121
PRK 5K LUMENS								
Wattage	T1	LPW	T3L	LPW	T5LS	LPW	T5LR	LPW
25	3177	127	3164	127	3191	128	3158	126
35	4448	127	4430	127	4468	128	4477	128
45	5643	125	5621	125	5668	126	5764	128
55	6750	123	6723	122	6780	123	6988	127
65	7513	116	7408	114	7546	116	8248	127
75	9426	126	9224	123			9378	125
85	10454	123	9688	114			10470	123
95	11004	116					11483	121
105							12680	121
115							13673	119

PRK LED Specifications

PRK LED Mounting and Options

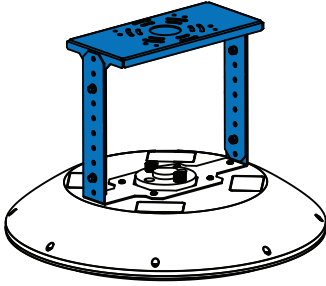

Trunnion Mount
Standard and
Tampered Screws

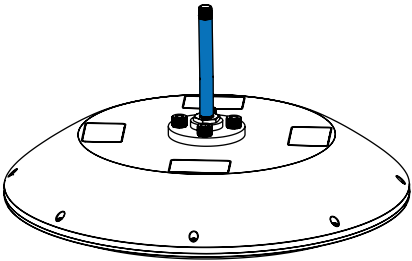

Pendant Mount
3/8 and 3/4" NPT Pipe
12, 24 & 36" Length

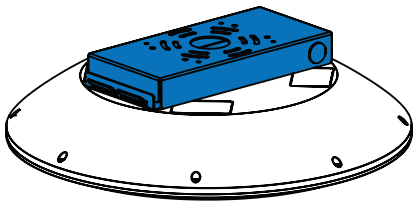

Ceiling Mount
Standard and Tampered
Screws

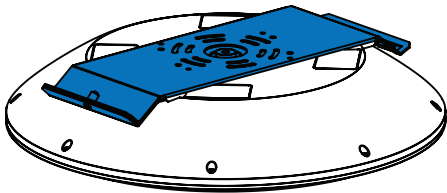

Low Profile Mount
Standard and Tampered
Screws

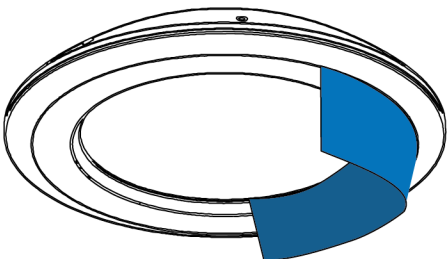

House Side Shield
Strict boundary line cutoff

PRK LED Mounting and Options

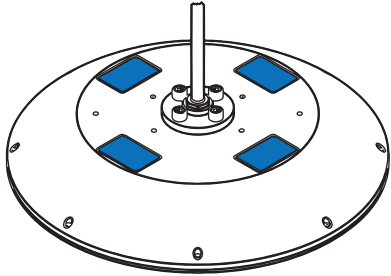

UPL
Up-light 800 lumens

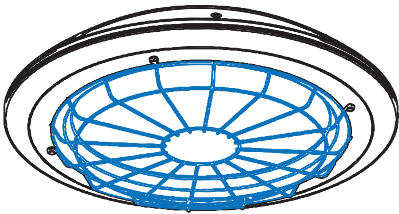

WG
Wire Guard

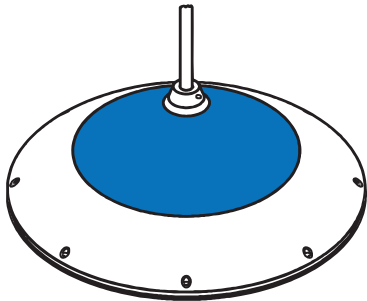

WLG
Wild Life Guard
*Pendant Mount Only

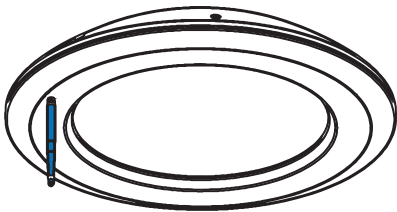

VWC
Visionaire
Wireless Controls
*Consult Factory

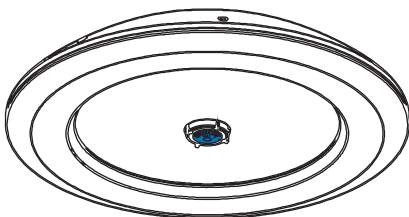

WSC-8
Dimmable Motion Sensor 8' Mounting Height
WSC-20
Dimmable Motion Sensor 9-20' Mounting Height
WSC-40
Dimmable Motion Sensor 21-40' Mounting Height

*WSC options will require (1) FSIR 100 remote for programing